

Measuring Microscope VMM200



Revision No: 03

Precise measuring microscope with binocular or video tube and brilliant optics, hand driven or motorized.



Technische
Mikroskopie

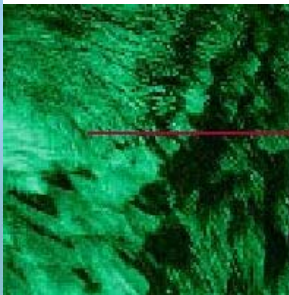

Measuring all and Seeing all

The modular concept offers each and every customer his own tailor-made unit configuration.

- Industrial fields of application: Machines and equipment construction, automobile production plants, aircraft and aerospace industries, electrical engineering and electronic industry, precision mechanics and optical fields, and medical technology.
- Technical Engineering and Universities.
- Laboratories: Inspection and calibrating laboratories, and technical laboratories for crime investigation.
- Operational research areas: Quality control, parts production, research and development, tools and moulds construction, and materials engineering.
- Spectrum of parts: Machining and chipless of producing parts, bended and perforated parts, die-casting parts, motor and gear parts, screws, cutting tools, electrodes for spark eroding, templates, stencils, scales, and medical implants.
- Task settings: Measurements of lengths and angles, profile forms, thickness of layers, material analysis, material fractures (cracks).
- Materials: Metals, plastics, ceramics, glass, rubber.

The Mechanical Basis

- Solid and massive base body of grey iron casting.
- Extreme high stability of measuring arrangement with very low sensitivity against short-time temperature changes.
- Utmost stable measuring stage with roll bearing guides.
- Highly permitted stage load.
- Measuring stages with measuring ranges (X/Y) of 150 x 100 and 250 x 150 mm.
- Fast positioning of measuring stage via free shifting of hand and comfortable precise adjustment of each coordinating direction via screws. Optionally available with motor drive.



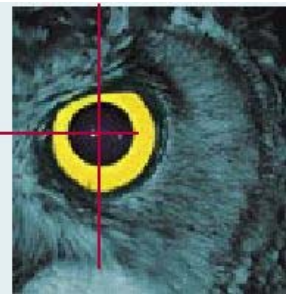

The Measuring Systems

- Opto-electronic measuring systems based on incremental-divided scales; resolution 0.0001 mm.
- Optional with digital measuring system in coordinate direction Z, measuring range 150 mm.
- Highly accurate since very low error possibility.
- Feed-back possibility on PTB Certificated Calibration Norm.
- Tested positioning accuracy according to VDI/VDE 2617.

The Optic is essential

- Measuring objectives TELEPLAN for measurements of lengths and forms.
- Micro objectives PLAN FLUOR for surface observations, e.g. metallurgy.
- Objectives with telecentric ray path meaning even by inexact focusing of object viewing, the image size stays unchanged – an indispensable condition for high accurate measurements.
- Objectives of highest optical quality, perfectly corrected, plane and distortionless images - all *designed by Leica*.
- Large working distances for high work-pieces.
- Easy exchangeable objective with a single hand grip via the bayonet mount.
- Video camera connection for further image processing.
- Binocular tube.
- Image viewing through bright-field and dark-field, with and without polarised light as well as differential interference contrast (DIC).

The Light

- External LED light source.
- Light supply by fibre optic light guide, thereby no heat transfer.
- Illuminating variants: Transmitted light, incident light, oblique incident light and ring light.
- For metallurgical examination: Bright-field, dark-field, interference contrast and polarisation.



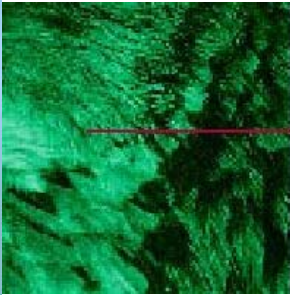

Introduction



Processing of measured values

The matching software for each application.

- **MX230**

The compact digital read-out unit with display of 3 axes and integrated calculating functions without image processing for quick measurements in the shopfloor.



- **Metlogix M2**

Advanced multi-touch application on a tablet PC for 2-4 axes. Clear user interface with displays and symbols. Digital read-out, graphical part view and report with tolerance evaluation and comprehensive data export facilities are the main features.

Can be used with manual microscopes.

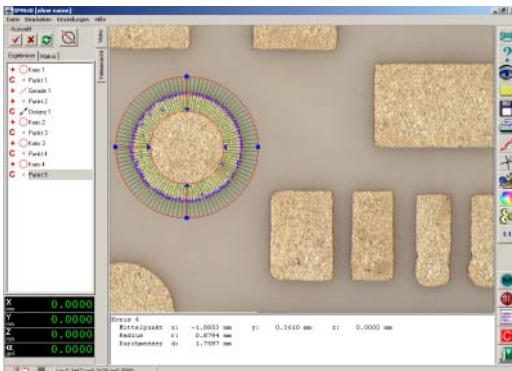

- **OMS**

The flexible, easy-to-learn measuring software from UHL; ideally for measuring of first-off samples and small batches. Flexible on-screen masks and measuring lines (distance / angle) for easy visual inspection. Multiple measuring tools with automatic edge detection

Can be used with manual and motorized microscopes.

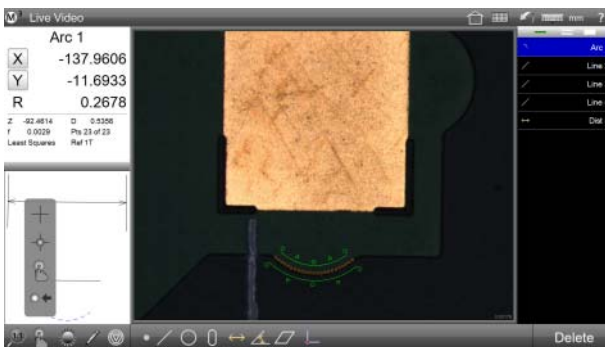

- **Metlogix M3**

Enhancement of the M2 software with imaging functions. Elements can be measured just by fingertip on the touch screen or classically by mouse.

Can be used with manual and motorized microscopes.



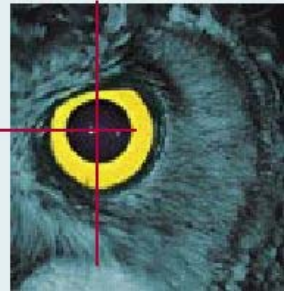

Accessories

- Field inserts with crosshair and concentric circles for radius measurements.
- Angle measuring insert with digital measuring system (Q).
- Centre support in conjunction with aperture iris insert and interference slit insert for diameter illumination of cylinders.
- Micro optical attachment for micro objectives.
- Ring light and oblique incident light.



Technical data

Measuring Microscope VMM 200 Main Unit with Measuring Stage

Main unit:	solid grey cast iron
Optics holder:	guided roll bearing, coaxial coarse and fine focus; optional Z-measurement (opto-electronic linear scale).
Movement range:	150 mm
Measuring stages:	
Measuring range:	150 x 100 mm and 250 x 150 mm
Guiding:	roll bearing
Movement:	fast and fine adjustment
Swivelling stage plate:	only with measuring stage 150 x 100 mm
Swivelling range:	$\pm 5^\circ$
Fasteners:	2 T-slots
Max. weight limit:	20 kg
Measuring system:	opto-electronic with incremental-divided scale
Resolution:	0.0001 mm
Accuracy limit for a coordinate direction, valid for working temperature range:	$1.8 \mu\text{m} + 0.0025 * L \mu\text{m}$
Lighting:	coaxial incident and transmitted light, transmitted light with aperture iris control.
Light sources (accessories):	with stepless brightness control, separately arranged
Light supply:	through fibre optic light guide

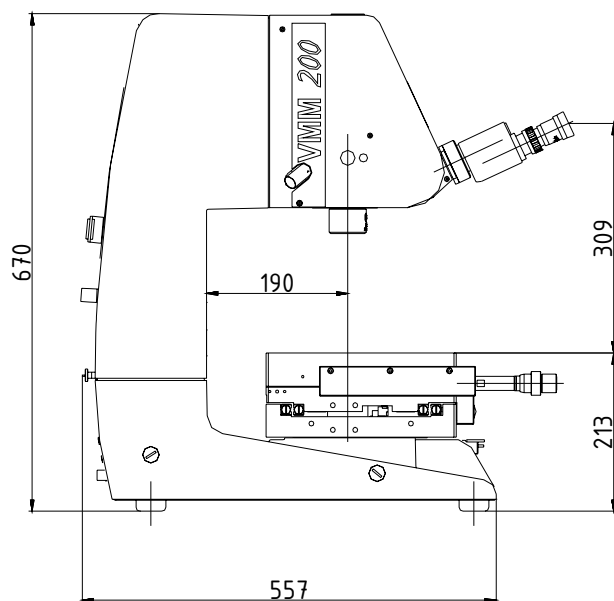
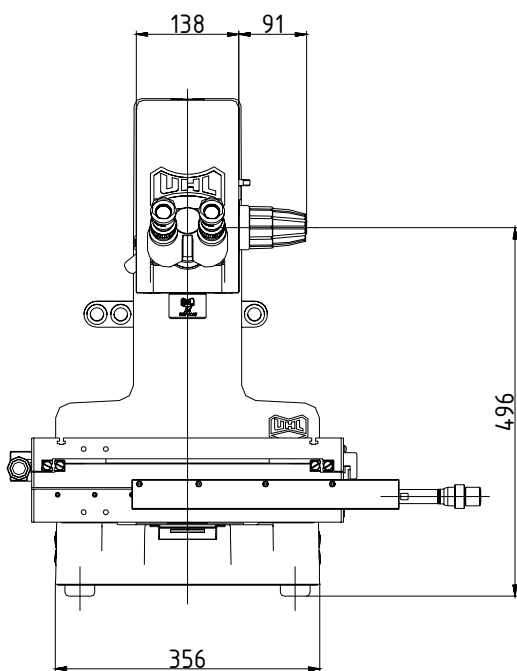

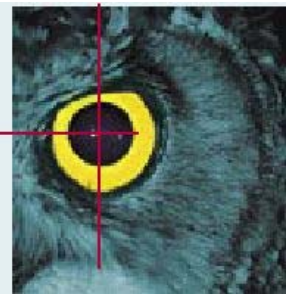

Optical System

Measuring tube:	binocular with dioptic compensation
Eye-pieces:	10x, with eye cups, (FOV18)
Viewing angle:	25°
Image:	upright and laterally true image
Total magnification:	see table for objectives
Measuring objectives:	changeable, telecentric ray path
Measuring or video tube reception:	bayonet mount
Further technical data:	refer to "Accessories"
Micro objectives:	for viewing surface structures
Technical data:	refer to "Accessories"

General

Operating temperature:	10° C to 40° C
Working temperature:	20 +/- 0,5° C
Storage temperature:	-10° C to 60° C
Power supply:	120/230 Vac, 50/60 Hz
Weight (net)	
Main unit No.VM4-BT01:	140 kg
Protective mode (CEI/IEC 529,DIN 40 050):	IP40
Electromagnetic amicability:	EN 50081-1, EN 50082-1, EN 61000-4, EN 61010-1



Revision No: 03

Manual-operated Measuring Microscopes

Equipment variants of ready-to-use Measuring Microscopes VMM 300 with binocular measuring tubes for metrological application.

Variants	Main unit with binocular measuring tube stage / measuring range 150 x 100 mm 250 x 150 mm KT8-LHMA KT9-LHMA		Measuring system coordinate direction Z	Digital read-out Metlogix	Order No.
	VM4-110	VM4-110	VM4-101	MX230	
1		●	●	●	VM4-BT01
2	●		●	●	VM4-BT02
3		●		●	VM4-BT03
4	●			●	VM4-BT04

All types are also available as motorized version, incl. joystick and 3 axis motion controller (e.g. VM4-BT01M).



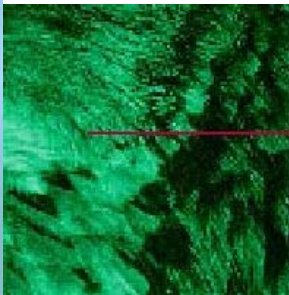

Manual Main Units

Main Unit with Binocular Measuring Tube UHL Measuring Microscope VMM 200 (with measuring stage, without digital read-out)

Consisting of following components:

1 Base body VMM 200 of grey cast iron, vertical column with adjusted Z-guiding (movement range 150 mm), fibre optic light guide for transmitted illumination

1 Mechanical fast and fine adjustment of focus

1 Binocular measuring tube*, with dioptric compensation, bayonet mount for measuring objectives or micro optical attachment, reception for the eye-pieces, connection for video camera adapter plus angle measuring device etc., with fibre optic light guide for coaxial incident illumination

1 Field insert with crosshair 90° and 2 additional lines $\pm 60^\circ$, usable in conjunction with binocular measuring tube

2 Eye-pieces, 10x magnification, with eye cups

1 Measuring objective 2:1, free-working distance $a = 85 \text{ mm}$

1 Aperture iris insert for transmitted light, knurled wheel for aperture iris control

2 LED cold light sources, 65 W
stepless brightness control

Order No. VM4-110

VM4-001

VM4-200

VM4-300

VM4-301

WX10XL

OP1-M02

VM4-512

VMP-GLL



* optional with angle-adjustable binocular tube VM4-300S

Measurement stage with 150 x 100 mm travel range

Order No. VM4-602

(coordinate direction X and Y), roll guided bearings for stage movement, stage surface 320 x 240 mm, swivelling stage plate with $\pm 5^\circ$ swivelling range, 2 T-slots to fasten samples, incremental opto-electronic measuring systems with steel linear scales, fast and fine adjustment.



Measurement stage with 250 x 150 mm travel range

Order No. VM4-600

(coordinate direction X and Y), roll guided bearings for stage movement, stage surface 420 x 256 mm, 2 T-slots to fasten samples, incremental opto-electronic measuring systems with steel linear scales, fast and fine adjustment.



Measuring system for coordinate direction Z

Order No.

Opto-electronic measuring system for coordinate direction Z, incremental-divided scale, resolution 0.0001 mm

VM4-101



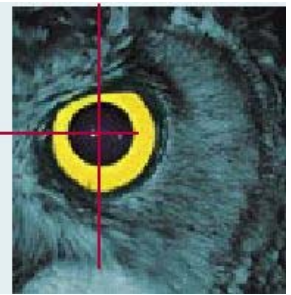

Processing of measuring signal and result output



- Compact Digital Read-out units for 3 axes
- Numerical and alphanumerical displays for functions.
- Numerical interval 0.0001 mm.
- Selectable languages:
German, French, English, Italian, Spanish, Portuguese, Chinese.
- Calculable alignment of work-pieces.
- Calculating functions for geometrical combination of the measured values.
- Programmable measuring sequences.
- Memory for measured values.

- Digital output RS 232.
- USB-connection.

Digital Read-out unit QC 200

3-axis digital read-out

Possibility to connect either a Z-axis or a Q-axis (configurable by software)

Order No.

MX230

Revision No: 03

Programmable Measuring Functions

- Measuring without manual calculation.
- No mechanical work-piece alignment owing to the calculated transformation of coordinates.
- Measuring of circle diameters with 3 to 50 points.
- Right-angled cartesian and polar coordinate systems.
- Combination of up to 50 measured values per geometrical element.
- Location of origin points upon user's choice.
- PRESET function
- Graphical view of geometry elements



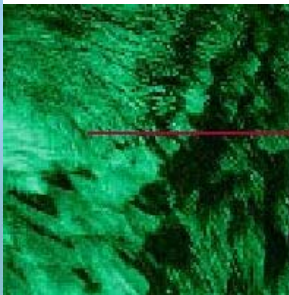

Motorized Main Units

Motorized Measuring Microscopes

Equipment variants of automated and semi-automated Measuring Microscopes VMM 200 with binocular measuring tubes or video tubes for metrological application.

Ordering code VMM 200:

VM4-AO01

Component description
Measuring microscope
VMM 200

Video adapter for binocular tube:

1 = C-Mount 1,2x (VM4-410)

2 = C-Mount 0,4 - 1,2x (VM4-411)

with video tube:

1 = integrated video c-mount

Measuring stage:

0 = VM4-601 (measuring range 250 x 150 mm)

Image Processing System:

O = OMS (VM4-OMS)

M = Metlogix M3 (VM4-M3)

Main unit:

A = motorized, with video tube (VM4-112)

B = motorized, binocular tube (VM4-111)

Example configuration:

VM4-AO01 Motorized main unit with video tube **VM4-112**, measuring software OMS **VM4-OMS**, measuring stage **VM4-601** 250 x 150 mm

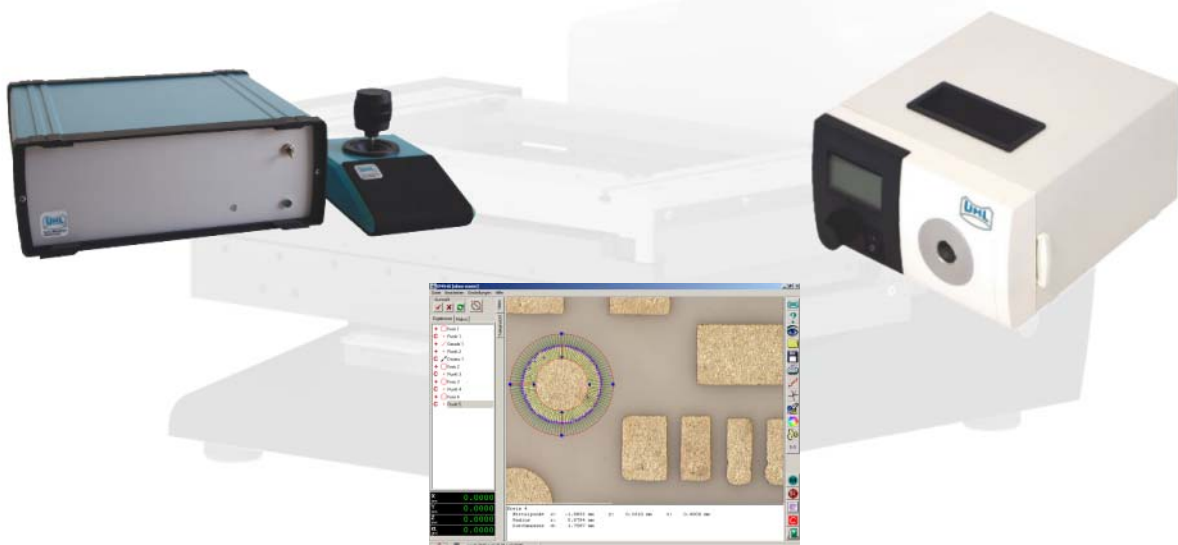

Motorized Main Units

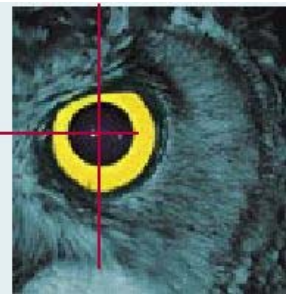

Main Unit with Video Measuring Tube UHL Measuring Microscope VMM 200

(with measuring stage and without image processing system)

Order No. VM4-112

consisting of following components:

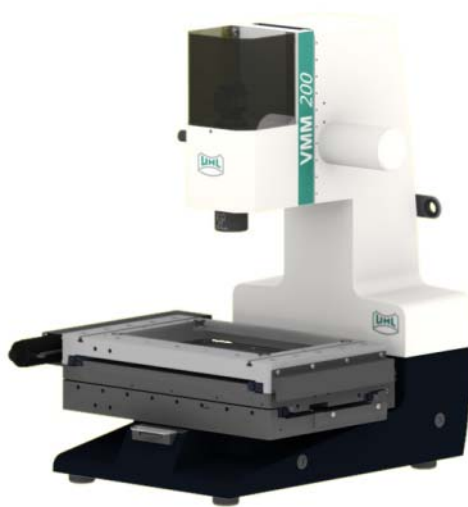

- | | |
|---|---------|
| 1 Base body VMM 200 of grey cast iron, vertical column with adjusted guiding (movement 150 mm), fibre optic light guide for transmitted illumination | VM4-001 |
| 1 Motorized Z-drive for focusing, with reception for measuring tube | VM4-204 |
| 1 Measuring system for coordinate direction Z | VM4-101 |
| 1 Video measuring tube, bayonet mount for measuring objectives or micro optical attachment, with C-Mount adapter for a video camera and fibre optic light guide for coaxial incident illumination | VM4-303 |
| 1 Measuring objective, 2:1, free-working distance $a = 85$ mm | OP1-M02 |
| 1 Aperture iris insert for transmitted light | VM4-512 |
| 1 Motorized measuring stage 250x150 mm | VM4-601 |

Main Unit with Binocular Measuring Tube UHL Measuring Microscope VMM 200

(with measuring stage and without image processing system)

Order No. VM4-111

Similar version as above-mentioned (VM4-112) but instead of VM4-303 with:



- | | |
|---|---------|
| 1 Binocular measuring tube* | VM4-300 |
| 2 Eye-pieces, 10x magnification;
Order no. for one piece | WF10XL |

* optional with angle-adjustable binocular tube VM4-300S

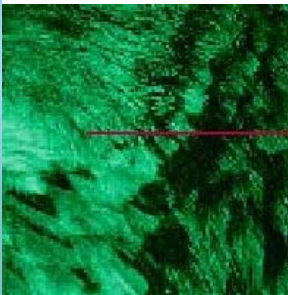

Motorized Main Units

OMS

The flexible, easy-to-learn measuring software for two dimensional measurements of primary samples and small batches by either hand-operated or motorized-operated measuring microscopes, for use in laboratories or production areas.

- Element-related combination of geometrical forms in a tree structure.
- Simple manual placement of the measuring points in the video image via the mouse.
- Immediate result display in a text protocol.
- Easy in memorizing or programming of measuring sequences and additionally the possibility of automated edge findings.
- Rectangular, circular, lattice and interactive image screen masks can be created as measuring frames for quick, visual control.

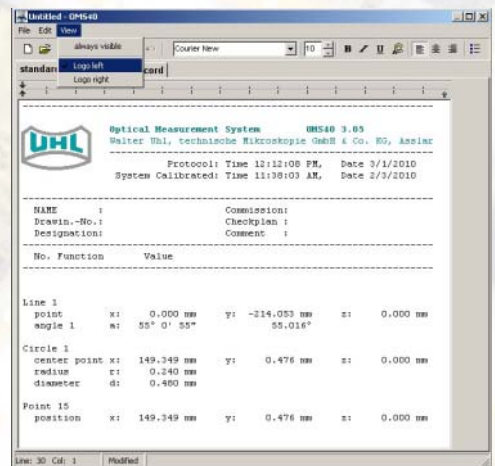
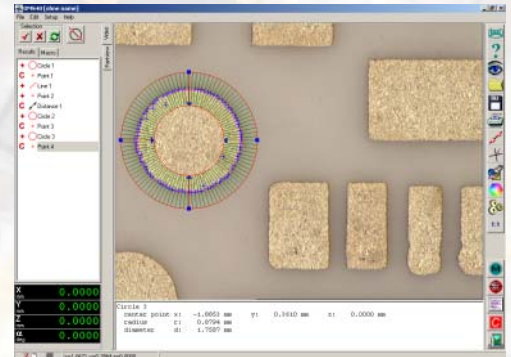

Measuring Software System UHL OMS Complete system for 3 axes

Order No. **VM4-OMS**

consisting of following components:

- 1 Desktop-PC with a 19" TFT monitor
- 1 Software Package OMS
- 1 3-axis stepper motor control system with Joystick
- 2 Cold light sources, remote controlled
- 1 High resolution color camera

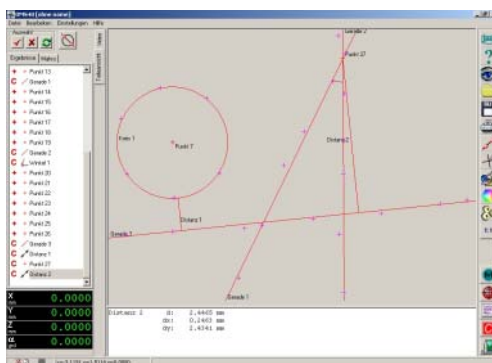

Motorized Main Units

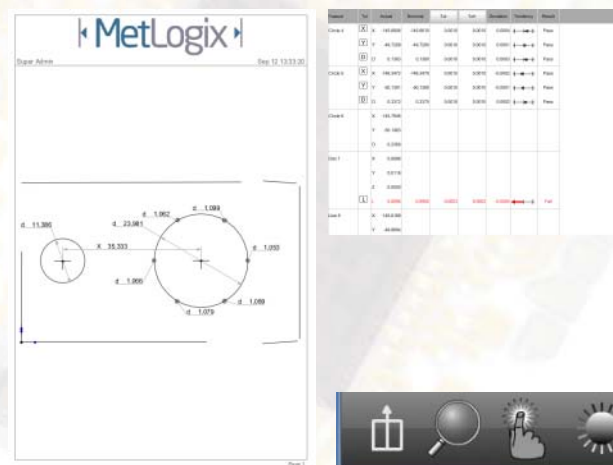
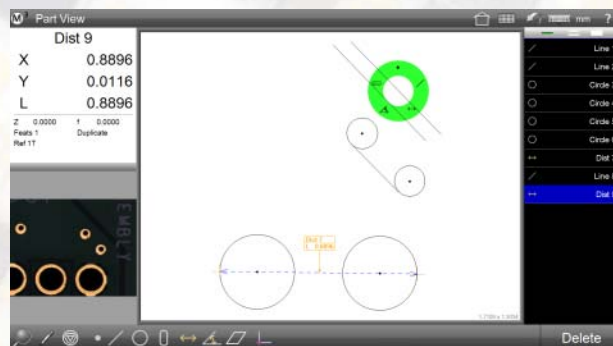
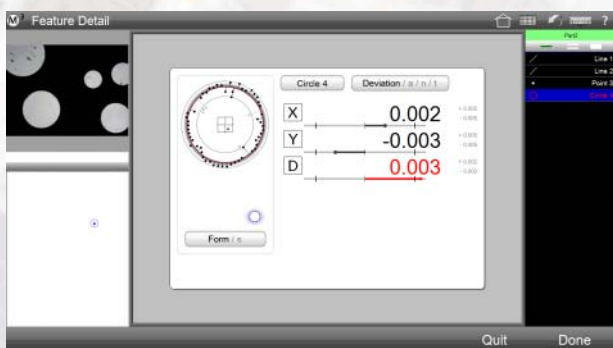
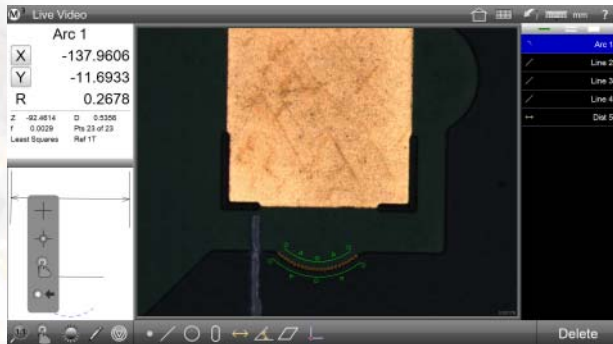
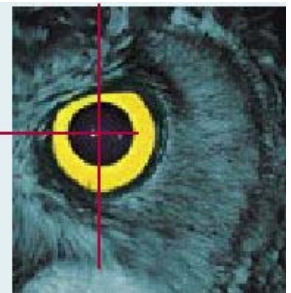

Metlogix M3

- comes with following standard functions:

- Intelligent imaging functions to measure regular 2D geometry elements
- Combinations and relations from measured elements
- Leveling and alignment functions
- Part programs
- Tolerance evaluation according to Din/ISO
- Multiple coordinate systems
- Multilingual
- Data export and printout with graphic
- Dimensioning of the part view
- Image export with/without measuring result
- Light control
- Optimal edge detection by „Measure Logic“ or active/fixed crosshair

Measuring software system Metlogix M3 Complete system for 3 axes

Order No. VM4-M3

consisting of following components:

- 1 All-In-One PC with touchscreen and the software Metlogix M3
- 1 Motion controller for 3 axes
- 2 Cold light sources, remote controlled
- 1 High resolution color camera

Option: DXF module to compare the measurements with the drawing, good/bad evaluation

M3.DXF



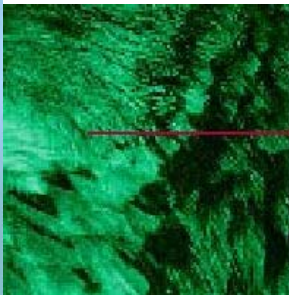

Accessories

UHL Measuring Microscope with Binocular Measuring Tube

A video camera with C-mount connector can be assembled when using one of the following adaptors.

C-Mount Adapter with 1.2x magnification

Order No. **VM4-410**

consisting of following components:

1 Video adapter with 1.2x magnification	VM4-400
1 C-Mount camera connecting piece	VM4-402



C-Mount Adapter with integrated magnification changer

Order No. **VM4-411**

consisting of following components:

1 Video adapter with integrated magnification changer 0.4x / 1.2x, suitable only for 1/2" cameras	VM4-401
1 C-Mount camera connecting piece	VM4-402

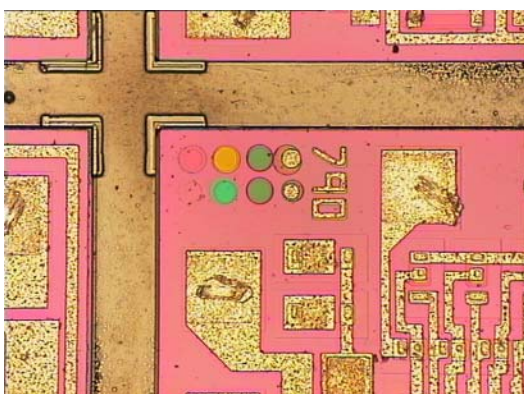

- Semiconductor, bright-field, 20x Plan-Fluor with video adapter 0.4x.

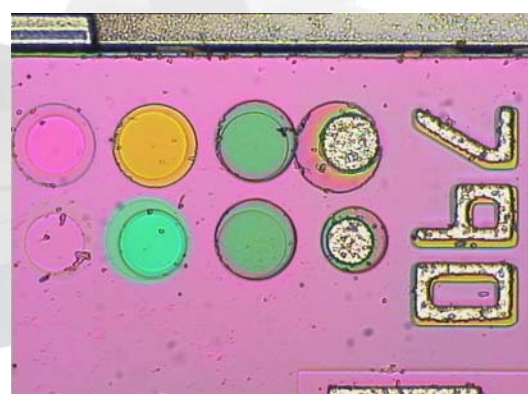

- Semiconductor, bright-field, 20x Plan-Fluor with video adapter 1.2x.



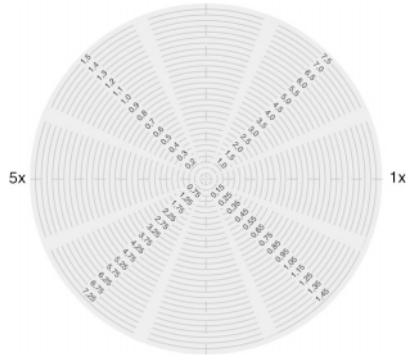
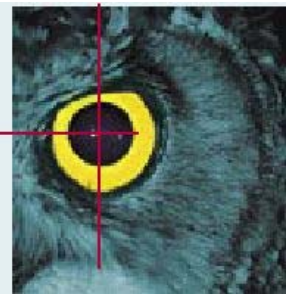

Field insert with crosshair and concentric circles

Order No. VM4-304

Crosshair 90° with 2 additional lines $\pm 60^\circ$ as well as each 2 sets of 30 concentric circles

Usable in conjunction with binocular measuring tube VM4-300

Total magnification	Diameter	Increments
10x	0.25 to 7.50 mm	0.250 mm
20x	0.25 to 3.75 mm	0.125 mm
50x	0.05 to 1.50 mm	0.050 mm
100x	0.05 to 0.75 mm	0.025 mm

Angle measuring insert with digital measuring system

Order No. VM4-302

Rotatable crosshair combined with opto-electronic measuring system, based on an incremental-scale, usable in conjunction with binocular measuring tube VM4-300



Illumination Unit for Oblique Incident Light

Order No. VM4-503

Suitable for measuring objectives 1:1 to 10:1, with dual arm fibre optic light guide, swivel holder $\pm 45^\circ$ around the optical axis, cold light source VMP-GL



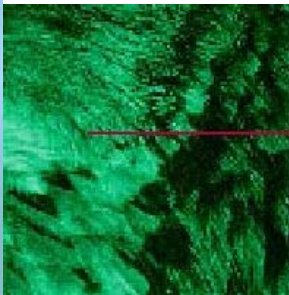

Accessories

Ring Light - Illumination Unit

Order No. **VM4-506**

Suitable for all OP1-M measuring objectives, with one fibre optic light guide.

For use in connection with cold light source VMP-GL or VMP-GLL.

add-on devices:

Set of polarisation filters **RL2.09**

Diffusor **RL2.10**

Segment aperture **RL2.11**



Automatic LED Cold Light Source

Order No. **VMP-GLL**

Hand- or computer-driven (by USB), approx. 640 lumen, stepless brightness control



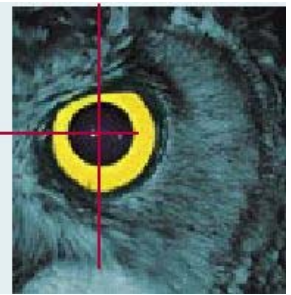

4 Segment LED Ring Light - Illumination Unit

Order No. VM4-508Q



Suitable for all OP1-M measuring objectives, with power supply and intensity control, 40 LEDs

4 Segment LED Ring Light - Illumination Unit

Order No. VM4-509



Suitable for all OP1-M measuring objectives, with power supply and intensity control, 80 LEDs

4 Segment LED Ring Light - Illumination Unit remote controlled

Order No. VM4-507



Suitable for all OP1-M measuring objectives, with power supply and intensity control, remote control unit for IMS/OMS software via USB/RS232

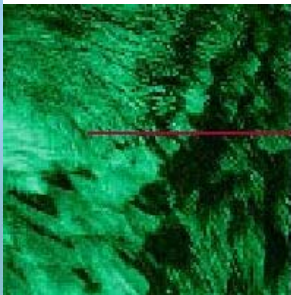

Accessories

Measuring objectives

Telecentrical measuring objectives of highest quality *designed by LEICA*, perfectly corrected, plane and distortionless images allowing a definable and precise edge detection.

Large working distances for measuring test objects e.g. disturbance edges or in bore holes.

Easily and quickly changeable secured fixing via the bayonet mount.



Lens magnification	Total magnification	Object-field diameter	Numerical aperture	Free-working distance	Sharpness depth	~ Probing accuracy	Order-No.
1 : 1	10-fold	20 mm	0,03	88	0,3	5	OP1-M01
2 : 1	20-fold	10 mm	0,06	85	0,08	3	OP1-M02*
5 : 1	50-fold	4 mm	0,13	62	0,02	1.5	OP1-M05
10 : 1	100-fold	2 mm	0,20	52	0,01	1	OP1-M10

* Measuring objective 2:1 included in basic version of UHL Measuring Microscope VMM 300.



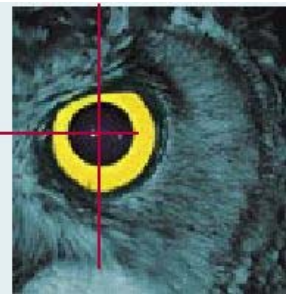

* Reduces the maximum specimen height to 135 mm

Micro Optical Attachment for 6 micro objectives*

Order No. VM4-310

consisting of:

1 Base body with changer for 6 micro objectives Plan Fluor 1.25:1 to 150:1	VM4-306
1 Fibre optic light guide	GF7
1 Triple illumination module (assembled in base body) for coaxial incident light (bright-field and dark-field)	VM4-307
1 Polarisation insert	VM4-363
optional: motor driven	VM4-310M

Micro Optical Attachment for 6 micro objectives and image viewing with polarised light as well as differential interference contrast (DIC)*

Order No. VM4-311

consisting of:

1 Base body with changer for 6 micro objectives Plan Fluor 1.25:1 to 150:1	VM4-306
1 Fibre optic light guide	GF7
1 Triple illumination module (assembled in base body) for coaxial incident light (bright-field and dark-field)	VM4-307
1 Polarisation insert	VM4-363
1 Plug-in unit for differential interference contrast (DIC) with adjustable Wollaston-Prism	VM4-364
optional: motor driven	VM4-311M



* Reduces the maximum specimen height to 135 mm

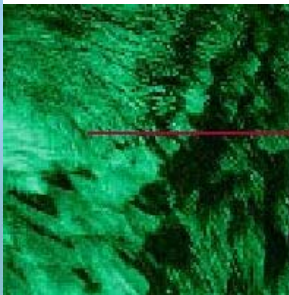

Accessories



Micro Objectives OLYMPUS Plan Fluor for image viewing with and without polarised light as well as differential interference contrast (DIC)

Suitable for both transmitted light and coaxial incident light; for use with the micro optical attachment VM4-311, and additionally usable in conjunction with the single bayonet mount VM4-308, or the micro optical attachment VM4-310. Objectives suitable for differential interference contrast are marked with „IK“ on the engraving.

Lens magnification	Total magnification	Field of view diameter	Numerical aperture	Free-working distance	Depth of focus (μm)	~ Probing accuracy	Order-No.
1.25 : 1	20 x	14.4 mm	0.04	3.5	170	5	OP1-LO001*
2.5 : 1	20 x	7.2 mm	0.08	10.7	43	3	OP1-LO002*
5 : 1	50 x	3.6 mm	0.13	15.0	16	1.5	OP1-LO005
10 : 1	100 x	1.8 mm	0.25	10.0	5	1	OP1-LO010
20 : 1	200 x	0.9 mm	0.4	12.0	2	1	OP1-LO020
50 : 1	500 x	0.36 mm	0.5	10.60	1	0.5	OP1-LO050
100 : 1	1000 x	0.18 mm	0.8	3.40	0.5	0.3	OP1-LO100
150 : 1	1500 x	0.12 mm	0.9	1.0	0.4	0.2	OP1-LO150

* not suitable for differential interference contrast



Accessories

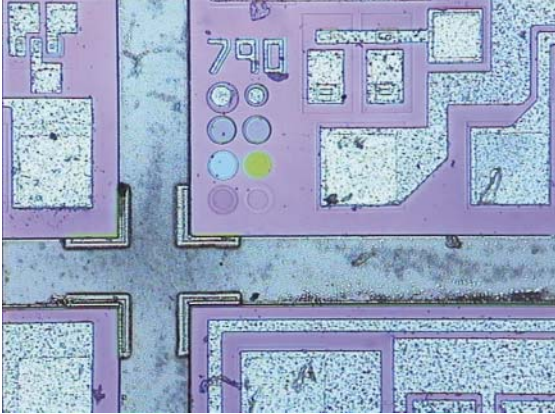
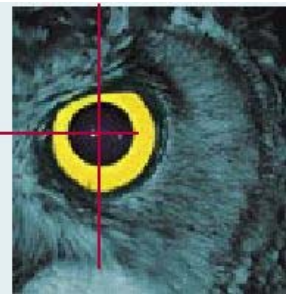

• Semiconductor, bright-field, 20x Plan-Fluor.

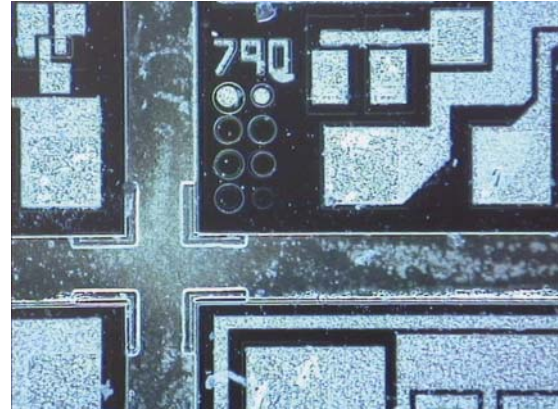

• Semiconductor, dark-field, 20x Plan-Fluor.

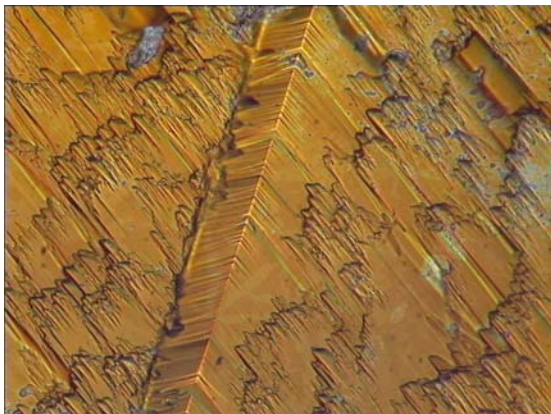

• Solar cell, bright-field, 50x Plan-Fluor.

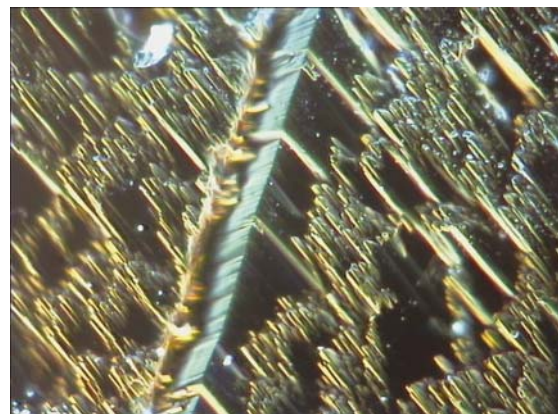

• Solar cell, dark-field, 50x Plan-Fluor.

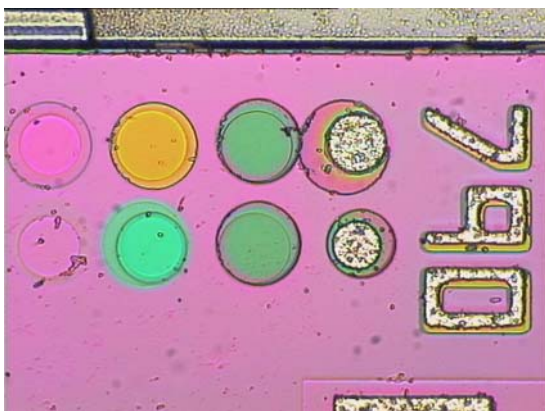

• Semiconductor, bright-field, 50x Plan-Fluor.



• Halbleiter, bright-field with differential interference contrast DIC, 50x Plan-Fluor.

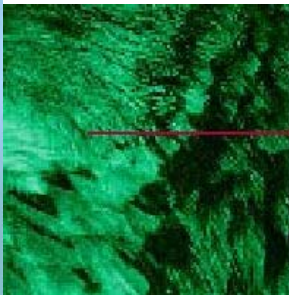

Accessories

Micro Optical Attachment for 4 micro objektives with extra long working distance*

Order No. **VM4-314**

Revolving attachment for 4 micro objektives 2:1 to 50:1



* Reduces the maximum specimen height to 115 mm



Apochromatic incident light objectives with extra long working distances, parfocalizing length 95 mm, RMS thread

Lens magnification	Total magnification	Field of view diameter	Numerical aperture	Free-working distance	Depth of focus (µm)	~ Probing accuracy	Order-No.
2 : 1	20x	9 mm	0,06	35,6	76	5	OP1-VX02
5 : 1	50x	3,6 mm	0,14	35	14	3	OP1-VX05
10 : 1	100x	1,8 mm	0,28	35	4	1.5	OP1-VX10
20 : 1	200x	0,9 mm	0,42	20,2	2	1	OP1-VX20
50 : 1	500x	0,36 mm	0,55	13,1	1	1	OP1-VX50



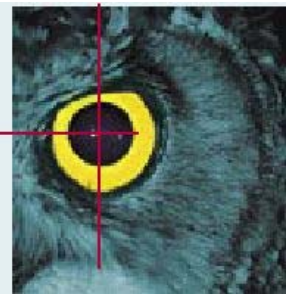

Ring Light - Illumination Unit

Order No. MS3-504

Suitable for all OP1-VX objectives, with one fibre optic light guide.

For use in connection with cold light source VMP-GLL.



LED Ring Light - Illumination Unit

Order No. RL8-LED

Suitable for all OP1-VX objectives, 16 LEDs

related power supplies:

Transformer with power supply

TR7-N

Transformer with power supply, remote controlled

TR7-NU

Revision No: 03



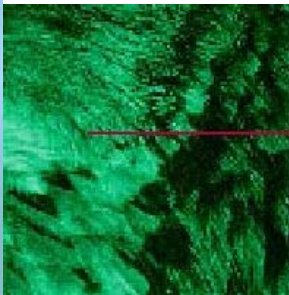

Accessories

rotary stage 360°

Order-No. **VM4-613**

Assembly for the stages VM4-600 and VM4-602 for easy angle measurement. By untightening the clamp, the stage can be moved by hand. A fine adjustment is used for an accurate measurement. The vernier has a resolution of 0.1°

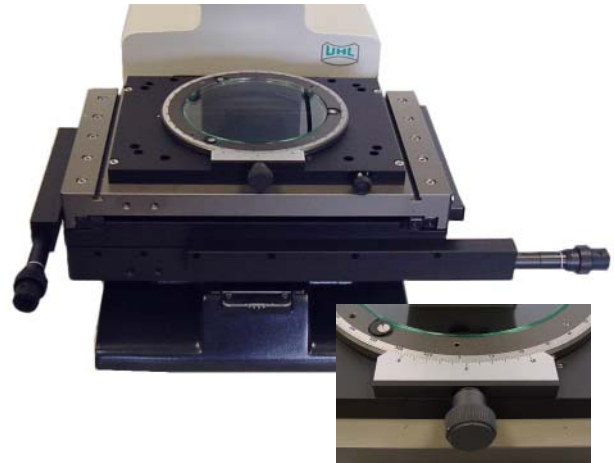

swiveling stage plate

Order-No. **VM4-610**

For product alignment on the stages VM4-600 and VM4-601.

swiveling range: $\pm 3^\circ$

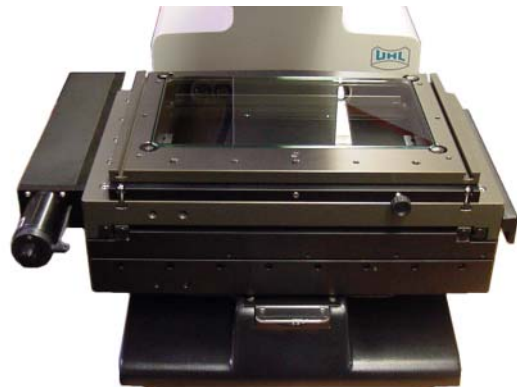

centre supports

Order-No.

For fixing turned parts on the stage VM4-602

optional swivelable

For fixing turned parts on the stages VM4-600 and VM4-601

optional swivelable

with handwheel drive

VM4-611

VM4-616

VM4-612

VM4-617

VM4-614



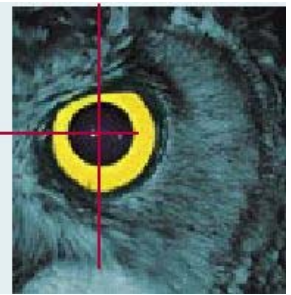

USB digital color camera

Order-No.

Digital cameras for the c-mount adapters (not included) to store images or view live picture (required for OMS or M3 software).

USB 3.0 interface

incl. PC-software for the image acquisition

1/1.8" resolution: 2048x1536 pixel
(suitable for VM4-410 + 411)

VM4-USB

1" resolution: 2592 x 2048 Pixel
(suitable for VM4-410)

VM4-USB5

optional:

Easy software to measure samples in the video image, movable lines for distance measurement, images can be watermarked and saved with a comment.

OMS-LT

OMS is available in german or english.

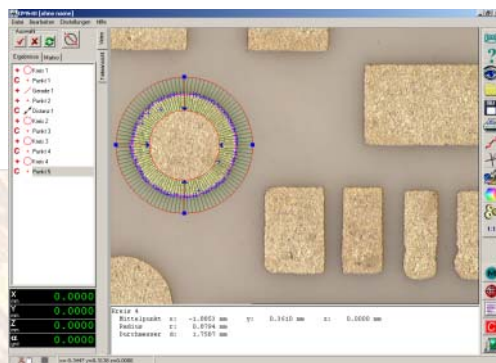

Revision No: 03



